



COMMERCIAL DESIGN GUARANTEED PERFORMANCE

PLANETARY MIXMASTER® POWER DRIVE

Bench Mixer with Accessory Drive Outlet

Instruction & Recipe Booklet

Please read these instructions carefully and retain for future reference



MX9500

Contents

Sunbeam's Safety Precautions	2
Congratulations	3
Features of your Café Series®	
Planetary Mixmaster® Power Drive	4
Using your Café Series®	
Planetary Mixmaster® Power Drive	6
Safety Mechanisms	12
Mixing Guide	13
Oven Temperature Guide	14
Care and Cleaning	15
Troubleshooting Guide	16
Ingredients	17
Cookery Tips for Best Results	18
Making a Successful Dough	20
Recipes	22

Important instructions – retain for future use.

تأكد من تفهم احتياطات السلامة المذكورة اعلاه

請務必理解上述的安全預防措施。

Assurez-vous que les précautions ci-dessus relatives à la sécurité sont bien comprises

Versichern Sie sich, dass die obenstehenden Sicherheitsmaßnahmen Verstanden werden

Βεβαιώσετε πως οι παραπάνω προφυλάξεις ασφαλείας γίνονται κατανοητές

Pastikan bahwa tindakan-tindakan keselamatan seperti di atas dimengerti anda

Accertatevi che le suddette norme di sicurezza siano comprese a dovere

上記の注意事項をよくお読みになり、安全を御確認ください

Уверете се дека погоре споменатите мерки на претпазливост се добро разбрани

Asegúrese de que las precauciones de seguridad precedentes sean bien comprendidas

کاری بکنید کہ احتیاط‌های بالا حتماً درک بشوند

ต้องแน่ใจว่า ข้อควรระวังเรื่องความปลอดภัยข้างต้น เป็นที่เข้าใจกันดี

Yukarda belirtilen güvenlik önlemlerinin anlaşıldığından emin olunuz

Xin kiểm chắc rằng những biện pháp làm an toàn kể trên được hiểu rõ

Sunbeam's Safety Precautions

SAFETY PRECAUTIONS FOR YOUR SUNBEAM CAFE SERIES® PLANETARY MIXMASTER® BENCH MIXER.

- Switch off the appliance and disconnect from supply before changing accessories or approaching parts that move in use.
- Never remove any attachment or accessory when the appliance is in operation; including the beater, Scrapemaster™ spatula beater, whisk, dough hook, pasta roller, pasta cutter.
- Ensure fingers are kept well away from moving beater, Scrapemaster™ spatula beater, pasta roller, pasta cutter, whisk or dough hook.
- Ensure that the bowl is secured and locked onto the base of the Power Drive Bench Mixer before commencing mixing.
- Do not unlock or remove the mixing bowl from the base of the Power Drive Bench Mixer whilst in use.
- Never tilt back the head of the Power Drive Bench Mixer whilst the appliance is in operation.
- When using extremely heavy loads the appliance should not be operated for more than 1 and a half minutes. This does not apply to the recipes detailed in this booklet.
- Ensure long hair is tied back and young children are not near the bowl.

Sunbeam are very safety conscious when designing and manufacturing consumer products, but it is essential that the product user also exercise care when using an electrical appliance. Listed below are precautions which are essential for the safe use of an electrical appliance:

- Read carefully and save all the instructions provided with an appliance.
- Always turn the power off at the power outlet before you insert or remove a plug. Remove by grasping the plug - do not pull on the cord.
- Turn the power off and remove the plug when the appliance is not in use and before cleaning.
- Do not use your appliance with an extension cord unless this cord has been checked and tested by a qualified technician or service person.
- Always use your appliance from a power outlet of the voltage (A.C. only) marked on the appliance.
- This appliance is not intended for use by young children or infirm persons unless they have been adequately supervised by a responsible adult to ensure that they can use the appliance safely.
- Young children should be supervised to ensure that they do not play with the appliance.
- Never leave an appliance unattended while in use.
- Do not use an appliance for any purpose other than its intended use.
- Do not place an appliance on or near a hot gas flame, electric element or on a heated oven. Do not place on top of any other appliance.
- Do not let the power cord of an appliance hang over the edge of a table or bench top or touch any hot surface.
- Do not operate any electrical appliance with a damaged cord or after the appliance has been damaged in any manner. If damage is suspected, return the appliance to the nearest Sunbeam Appointed Service Centre for examination, repair or adjustment.
- For additional protection, Sunbeam recommend the use of a residual current device (RCD) with a tripping current not exceeding 30mA in the electrical circuit supplying power to your appliances.
- Do not immerse the appliance in water or any other liquid unless recommended.
- This appliance is intended to be used in household and similar applications such as: staff kitchen areas in shops, offices and other working environments; farm houses; by clients in hotels, motels and other residential type environments; bed and breakfast type environments.

If you have any concerns regarding the performance and use of your appliance, please visit www.sunbeam.com.au or contact the Sunbeam Consumer Service Line.

Ensure the above safety precautions are understood.

Congratulations

Congratulations on the purchase of your Sunbeam Café Series® Planetary Mixmaster® Power Drive Bench Mixer.

The Sunbeam Café Series® delivers quality, style and superior performance capturing the essence of the commercial kitchen. Inspired by heavy-duty equipment found in restaurants, cafes and bars, the Sunbeam Café Series® is built to last. It brings together a range of appliances designed to expertly create authentic café food and beverages at home.

Uncompromising blends of stainless steel, brass and die-cast alloy characterise the range. This combined with advanced technology and functional design, guarantee the performance, that each product will surpass expectations.

The Sunbeam Café Series® Planetary Mixmaster® Power Drive Bench Mixer is designed with quality die-cast metal components and includes many features that make mixing at home easy.

Features of your Café Series[®] Planetary Mixmaster[®] Power Drive Bench Mixer

Drive Outlet

The drive outlet allows for the attachment of a range of accessories including pasta rollers and pasta cutters.

1200W motor

Powerful motor achieves thorough mixing results.

Full die-cast metal body with sintered metal gears

The heavy duty die-cast metal body combined with sintered metal gears deliver quality, style and superior performance.

Planetary mixing action

Enables the mixing attachment (beater, Scrapemaster™ spatula beater, whisk or dough hook) to rotate whilst travelling around the inside of the bowl, and reach all areas of the bowl ensuring ingredients are completely mixed.

Splashguard with pouring chute

Splashguard prevents ingredients from spilling out of the mixing bowl. The pouring chute allows adding ingredients directly into the mixing bowl without having to stop the mixer and lifting the mixer head.

Overmould Handle

The handle on the mixing bowl allows for ease of use during operation and the overmould handle provides comfort for your hand.

Slow start

The mixing speed is gradually increased to prevent ingredients splashing out of the mixing bowl.

Stainless steel mixing bowl

The 4.5L mixing bowl is ideal for mixing large or small quantities of ingredients.

Cord storage

For added convenience the unused cord length can easily be pushed into the base of the mixer for storage.

Pause / Start button

Allows you to instantly stop the mixer to assess the mixing progress and/or add additional ingredients without affecting the timer.

Carrying grips

Grips at both sides of the mixer base allow for easy carrying.

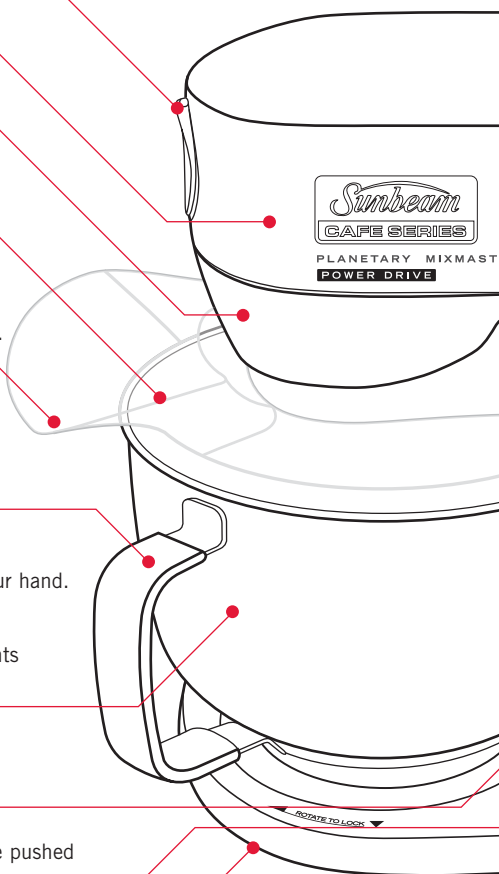

Using your Café Series® Planetary Mixmaster® Power Drive Bench Mixer

Before using your Power Drive Bench Mixer

Before using your Power Drive Bench Mixer for the first time, remove any packaging material and promotional labels or tags. Please also remove the plastic plug pin cover before using the mixer. It is recommended to wash the mixing bowl, beater, Scrapemaster™ spatula beater, whisk and dough hook in warm soapy water with a soft cloth. Rinse and dry thoroughly.

Set-up of your bench mixer

Before assembling your Power Drive Bench Mixer, be sure the power cord is unplugged from the power outlet. Position the mixer on a level, dry surface such as a bench top.

1. Press the 'head release' button, located at the rear of the mixer head. This will release the mixer head out of its locked position. Ease the mixer head backwards until it locks into its tilt position (Fig. 1).
2. Select the desired attachment depending



– Scrapemaster™ spatula beater for smaller amounts of mixture or for faster creaming of butter and sugar and heavy cake mixes. Also great for folding ingredients



– Whisk for whisking cream, egg whites, light batters and packet cake mixes.



– Dough hook for kneading dough and other heavy mixtures.

3. Attach the selected attachment onto the drive outlet using the bayonet attachment. Place the attachment into position with the feeder roll at the back. Simply push the roller back and down, to lock into position.

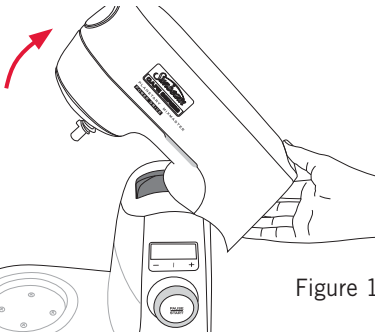

Figure 1

on the mixing task to be performed:

- Beater for creaming butter and sugar, plus mixing heavy cake mixes.

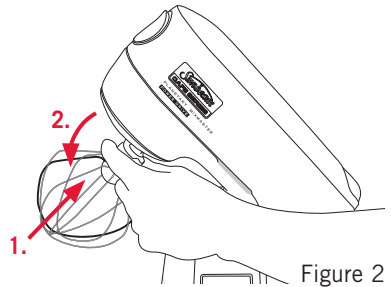

Figure 2

Note: Be sure the attachment is locked firmly in place.

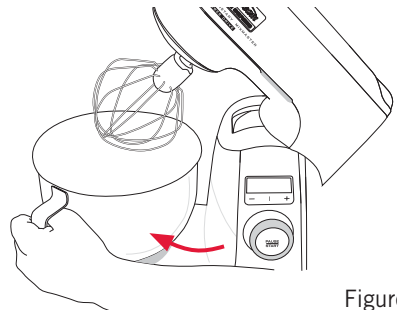

Figure 3

Using your Café Series® Planetary Mixmaster® Power Drive Bench Mixer continued

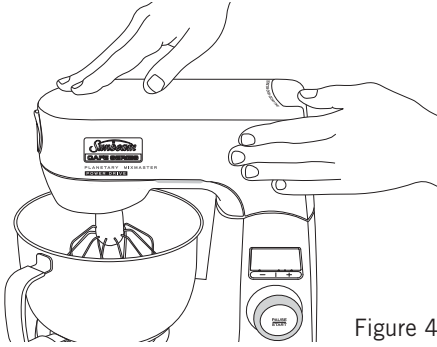

Figure 4

4. Place the bowl on the base with the handle facing you. Then gently rotate the bowl in a clockwise direction until it locks into position (Fig 3). The bowl should feel firm with no movement.
5. Lower the mixer head with the selected mixing attachment in place into the mixing bowl. Press the 'head release' button to un-lock it from its position and ease the mixer head down (Fig. 4).



Figure 5

6. The splashguard can now be placed over the bowl if desired (Fig 5).

Using your Planetary Mixmaster® Bench Mixer

1. Position the mixer on a level, dry surface such as a bench top. Ensure the mixing bowl is in place and the desired attachment is inserted.
2. Plug the power cord into a 230/240 Volt AC power outlet.
3. A beep will sound and the LCD screen will light up to inform you that the mixer is now switched on. The LCD screen will flash three times and the timer will display "00:00". The screen will also display the speed setting. If the LCD displays a speed setting other than "0" and continues to flash, you may turn the speed control dial anti-clockwise to the "0" position to re-set the speed setting.
- 4a. If using the splashguard, add ingredients to the mixing bowl through the pouring shoot.
- 4b. If using the mixer without the splashguard, release the mixer head out of its locked position and ease it backwards until it locks into its tilt position. Add ingredients to the mixing bowl. Then, un-lock the mixer head and lower it forward into the mixing bowl.
5. Turn the speed control dial clockwise to commence mixing (Fig. 6), or, if a speed is already set, press the **PAUSE START** button.

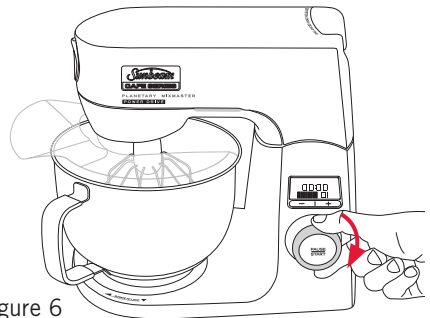

Figure 6

Using your Café Series® Planetary Mixmaster® Power Drive Bench Mixer continued

The LCD screen will display the chosen speed setting. Instructions for mixing speeds for each type of mixture are shown in the 'Mixing Guide' on page 15.

6. When mixing is complete, turn the speed control dial anti-clockwise to the '0' position (Fig. 7) and unplug the cord from the power outlet.



Figure 7

7. Remove the splashguard if positioned on the bowl.

8. Press the 'head release' button and ease the mixer head back until it is locked into the tilt back position (see Figure 1 on page 6).

9. To remove the particular mixing attachment, push it upwards, turn it anti-clockwise, then pull it downwards (Fig 8).

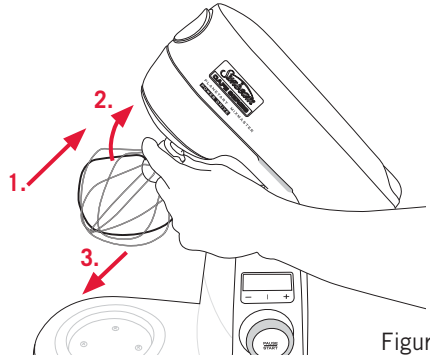

Figure 8

Using your Café Series® Planetary Mixmaster® Power Drive Bench Mixer continued

Pause mode

At any stage during your mixing task you can pause the mixer. This enables you to assess the mixing progress, scrape any food mixture down the sides of the mixing bowl with a spatula, or add additional ingredients - without affecting the timer.

Pause the mixer during operation by pressing the **PAUSE START** at the front of the speed control dial.

The time on the LCD screen will flash continuously, displaying the mixing time at which the mixer has been paused.

In pause mode, you are able to reset or adjust the timer if desired. Please see details on the Count-up and Count-down timer features below.

To resume your mixing task, simply press the **PAUSE START** button again. The mixer will resume mixing at the same speed setting, and the timer will resume counting up/down depending on your selection made.

Count-up timer

The count up timer informs you how long your ingredients have been mixing for. The next time you mix the same ingredients you can then set the count-down timer for the specific time.

As soon as you start mixing, the timer will automatically start to count up.

The maximum mixing time is 20 minutes and will be displayed on the LCD screen as **"20:00"** (twenty minutes, zero seconds).

The mixer will automatically stop mixing after 20 minutes and beep twice.

The screen will flash for about 5 seconds.

The timer will automatically re-set to **"00:00"**.

The LCD screen will display the speed setting that it stopped at and this setting will continue to flash.

If you pause the mixer at any time during the mixing process by pressing the **PAUSE START** button at the front of the speed control dial, the mixing time displayed on the LCD screen will flash until you resume mixing by pressing the **PAUSE START** button again.

To reset the timer to **"00:00"**, turn the speed control dial anti-clockwise to the **"0"** location or, when paused, press the **+** and **-** buttons simultaneously.

Using your Café Series® Planetary Mixmaster® Power Drive Bench Mixer continued

Count-down timer

The count-down timer is especially useful when following a recipe that specifies mixing times.

The '+' and '-' buttons allow you to choose the desired mixing duration. Press the '+' button and you will add 30 seconds. Press the '-' button and you will reduce the previously set mixing time by 30 seconds.

For example, if a recipe calls to "beat for 2 minutes", you can set the count-down timer to 2 minutes. Simply press the '+' button until "02:00" is displayed on the LCD screen, i.e. press the '+' button four times.

If you would like to change the countdown time after your initial setup, press the **PAUSE START** button, then press the '+' and '-' buttons to increase or reduce the mixing time to the nearest 30 sec increment.

For example, you set the count-down timer to 3 minutes and turn the speed control dial to start mixing on a chosen speed. After 1 minute, 25 seconds, you pause the mixer by pressing the **PAUSE START** button. The LCD displays the remaining count-down time of 01:35. If you now press the '+' button once to increase the mixing time, the display will show 02:00 (which is the nearest 30 sec increment).

To reset the timer to "00:00", turn the speed control dial anti-clockwise to the "0" location or, when paused, press the '+' and '-' buttons simultaneously.

When the chosen mixing time is completed, the mixer will beep twice to inform you that the time has expired. It will stop mixing automatically. The timer display "00:00" and the LCD screen will flash for about 5 seconds. The LCD screen will display the speed setting that it stopped at and this setting will continue to flash.

If you need to resume mixing, simply press the **PAUSE START** button or, alternatively, reset the mixer by turning the dial to "0", and then turn the dial clockwise.

Kitchen Timer function

The timer function can be used without mixing as a kitchen timer or stopwatch.

Timer: Set the time as described in the Count-down timer section on page 9, then press the **PAUSE START** button while the dial is in "0" (i.e. no speed selected).

When the set time expires, the mixer will beep and the LCD screen will flash continuously until the **PAUSE START** button is pressed.

Stopwatch: Simply press the **PAUSE START** button whilst in "0" (i.e. no speed selected). The maximum time the LCD screen can display is 90 minutes and will be displayed on the LCD screen as "90:00" (ninety minutes, zero seconds).

When the maximum time has been reached, the mixer will beep and the time display on the LCD screen will flash continuously until the **PAUSE START** button is pressed.

To reset the timer to zero ("00:00"), press the **PAUSE START** button, then press the '+' and '-' buttons simultaneously.

Using your Café Series® Planetary Mixmaster® Power Drive Bench Mixer continued

Set-up of your Power Drive

Before assembling your attachments to the Power Drive, be sure the power cord is unplugged from the power outlet. Position the mixer on a level, dry surface such as a bench top.

1. Remove the storage cover from the front of the mixer head by pulling down on the cover. (See Fig. 1).

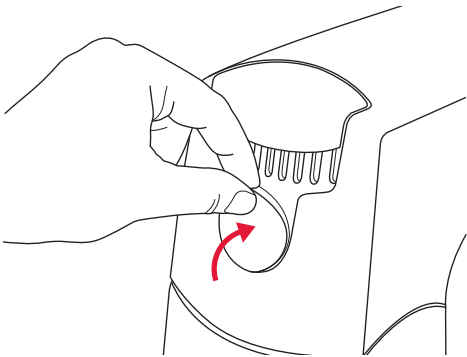
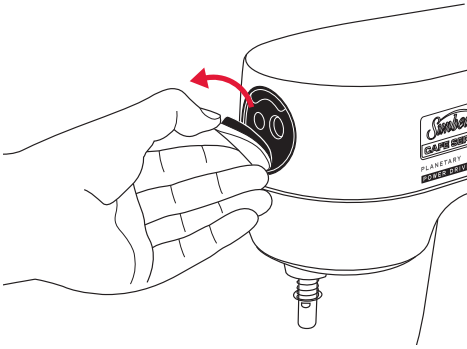

Store the cover in the storage location at the back of the mixer head'.

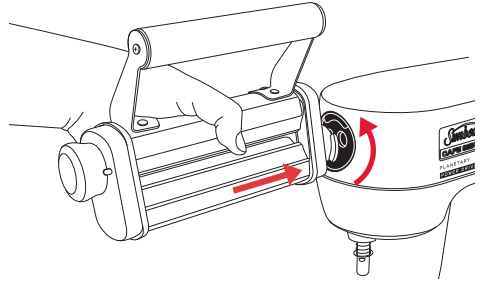

2. Select the desired attachment depending on the task to be performed. Refer to the instruction and recipe booklet for the accessory, for more details.

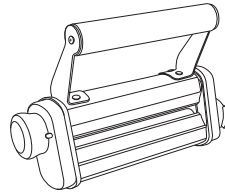

- use the pasta roller to roll pasta dough into sheets. This attachment is always used as first step when making pasta.

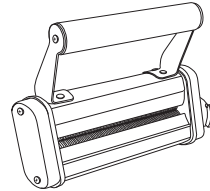

- the spaghetti pasta cutter cuts pasta sheets into pasta strands.

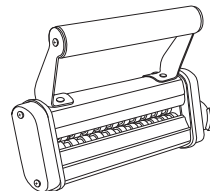

- the tagliatelle pasta cutter cuts pasta sheets into wider pasta strands.

Safety Mechanisms

Thermo cut-off – temperature overload

The mixer is equipped with a self-resetting safety device which safeguards against overheating the motor with excessive loads. If overheating occurs, the mixer will automatically activate the overheating protection device and switch itself off. The mixer will beep and the screen will flash continuously. Switch the mixer off and unplug it from the power point. Release the mixer head and tilt it back until it is locked into the tilt back position. Let the mixer rest for 30 min.

Electronic protection cut-out

If the mixing load is too heavy for the selected speed and prevents the attachment from rotating, the mixer will cut-out to prevent damage to the unit. If the LCD screen flashes fast and continuously, the motor has not been able to achieve or maintain the set speed. In this case, unplug the mixer and remove some of the mixture from the bowl, working in batches.

Mixer head safety mechanism

The mixer head must be locked down or the motor will not operate. If the mixer head is tilted upwards during operation, the mixer will automatically stop. This is a safety mechanism to avoid injury. To resume your mixing task, lock the mixer head back down and press the **PAUSE** **START** button.

Standby mode

The mixer will automatically switch off the LCD screen after 20 minutes to save power. To exit the standby mode, press any button or turn the dial.

Care and Cleaning

Before cleaning your Sunbeam Café Series® Planetary Mixmaster® Power Drive, ensure that the power is turned off at the power outlet, then remove the plug.

Wipe over the outside area of the Planetary Mixmaster® Power Drive including the head and base, with a dampened cloth and polish with a soft dry cloth.

Wipe any excess food particles from the power cord.

Sunbeam recommends to wash the mixing bowl, splashguard, beater, Scrapemaster™ spatula beater, whisk and dough hook in warm soapy water and wipe dry – use a brush if necessary to remove any sticky food particles.

All plastic components deteriorate through prolonged dishwasher use. However, parts of your Café Series® Planetary Mixmaster® are tolerant to dishwasher use. These include the stainless steel mixing bowl, beater, Scrapemaster™ spatula beater, whisk and dough hook.

Note: Place only on the top rack of the dishwasher.

Stainless steel whisk

After washing the stainless steel whisk, the outer wire may have moved out of position and become misaligned (see Figure 9). Please clip the outer wire back into position (see Figure 10).

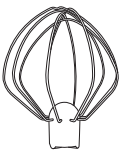

Figure 9



Figure 10

Maintenance Service

Your Sunbeam Café Series® Planetary Mixmaster® Power Drive should be regularly checked. After approximately four years of domestic use, the grease in the gear compartment should be examined. We suggest at that time you send the mixer to your nearest Sunbeam Appliance Service Centre to ensure efficient, correct servicing.

Storage

Keep your Sunbeam Café Series® Planetary Mixmaster® Power Drive in a convenient position on your kitchen bench ready for use at all times. Place the beater, Scrapemaster™ spatula beater, whisk and dough hook in the mixing bowl as storage of these attachments in a drawer with other kitchen equipment may cause damage.

Note: Never wind the power cord around the mixer after use as the warmth from the motor may cause damage to the power cord. For added convenience the unused cord length can easily be pushed into the base of the mixer for storage.

Troubleshooting Guide

Problem	Possible Cause	What to do
Motor will not start.	Motor is over-heated. Mixer head is not locked down properly.	Unplug and allow motor to cool, (the mixer head should be cool to touch). Move mixture in mixing bowl to the side of the attachment, to allow the attachment to go all the way into the bowl.
Motor is over-heated.	Use of a high speed for a long time. Mixture too heavy. Mixing quantity too large.	Unplug and allow motor to cool, (the mixer head should be cool to touch). Try mixing in batches.
Mixer head does not lock down properly.	Thick mixture is preventing the attachment from going all the way down into the bowl.	Move mixture in mixing bowl to the side of the attachment, to allow the attachment to go all the way into the bowl.
Attachment is hitting the bowl.	Attachment is not inserted correctly. Mixing bowl is not locked into the base properly.	Remove the attachment and try inserting again. Refer to the instructions in this booklet if needed. Lock bowl into position. Refer to the instructions in this booklet if needed.
Mixer is moving on the benchtop.	Chosen speed is too high for the mixture. Mixture caught up in the attachment. Flour or spills on bench top.	Lower the speed or mix in batches. Scrape down the attachment and continue mixing. Clean and dry benchtop as well as the mixer base.
Cannot use or set the timer, but the motor will start when the speed dial is being turned.	'+' button, '-' button or Pause/Start button was depressed when the unit was switched on.	Unplug from the power outlet for 5-10 seconds, then plug in again ensuring no buttons are pressed. If this problem persists, there may be food particles or liquid in the switch. The unit is safe to use in this mode, however Sunbeam recommends to take the product to an authorised service centre. For a complete list of Sunbeam's authorised service centres visit our website www.sunbeam.com.au or www.sunbeam.co.nz or call: Australia: 1300 881 861 New Zealand: 0800 786 232

Mixing Guide

Please keep in mind that the various mixing tasks and related speeds, listed in the table below, may vary slightly from recipe to recipe. Please refer to it regularly as you develop your understanding of how different ingredients interact when mixing.

SPEED SETTING RANGE	MIXING TASK
LOW 1-4	FOLDING & KNEADING Combining or initial mixing of ingredients Folding Kneading – doughs (pastry, bread, scones, etc.)
MEDIUM 5-7	LIGHT MIXING Kneading – heavy doughs Beating – sugar and butter, cake mixes
HIGH 8-10	CREAMING & BEATING Whisking – light batters Beating – heavy batters/icing
VERY HIGH 11-12	WHIPPING & AERATING Whisking – egg whites/cream

NOTES:

For most recipes, it is better to begin your mixing on a slower speed until the ingredients begin combining, then move to the appropriate speed range for the particular task.

Generally, there is not one set speed for an entire recipe. You will need to change the speed of the mixer depending on what stage of the recipe you are working on. This is communicated in the recipe section.

When mixing larger quantities you may need to increase the mixer speed due to the amount of mixing required and the larger load on the machine.

When making a recipe that requires the addition of dry ingredients, such as flour, slow the speed down whilst these ingredients are being added to avoid a snow storm effect. Once the additional ingredients begin combining then slowly increase to the appropriate speed for the particular mixing task.

Oven Temperature Guide

For your information, the following temperature settings are included as a guide.

DESCRIPTION OF OVEN TEMPERATURES	Degrees Celcius °C	Degrees Fahrenheit °F	Gas Mark
Very Slow	120	250	½
Slow	140-150	300	1-2
Moderately Slow	160	325	3
Moderate	180	350	4
Moderately hot	200	400	6
Hot	220	425	8
Very Hot	240	475	9

Note: If using fan forced ovens be sure to turn the temperature down by 20°C.
Also check recipes at the back of this booklet.

Ingredients

Measuring Ingredients

Careful and correct measurement of all ingredients is essential for recipe success (particularly when baking). Australian Standard Metric cup and spoon measures are used in all recipes in the book. All cup and spoon measurements should be level.

- One metric tablespoon is equal to 20mls.
- One metric teaspoon is equal to 5mls.
- One liquid cup measurement is equal to 250mls.
- All eggs used in our recipes are extra large (59g) eggs, unless otherwise specified.

The following are some hints on measuring ingredients.

When measuring wet ingredients, always use a measuring jug or if measuring small quantities, use a standard metric measuring spoon. Place the measuring jug on a level surface and check the measurement at eye level.

When measuring dry ingredients, always use a standard metric measuring cup or standard metric measuring spoon. Shake gently to ensure there are no air pockets and level the surface with a knife or metal spatula. Never tap the cup on the bench or pack in the ingredients (unless specified); this will give an inaccurate measurement.

Note: crush any lumps, particularly in bicarbonate of soda or sugar before measuring.

When measuring other ingredients, always weigh in grams using metric scales. To ensure an accurate reading, always remember to “tare” the scales back to zero with the empty container before adding any food.

Tips for substituting Ingredients

- Unsalted butter is best for cake baking, however it can be substituted with salted butter or margarine if necessary. Margarine may slightly alter the texture of the final result.
- Self raising flour = plain flour + baking powder (1 cup self raising flour = 1 cup plain flour + 2 teaspoons baking powder)
- 1 cup plain flour + 1 teaspoon baking powder = $\frac{1}{2}$ cup plain flour + $\frac{1}{2}$ cup self raising flour
- When substituting wheat flour with gluten free flour, the best results are usually achieved in recipes that have a small amount of flour.
- Commercial baking powders can contain wheat starch. If your allergic to wheat, you can make your own. Baking powder = 1 teaspoon bicarbonate of soda + 2 teaspoons cream of tartar
- Icing sugar mixture can contain wheat starch (this prevents it going lumpy). If you have a gluten intolerance, pure icing sugar can be used instead.
- Sultanas can be substituted with equal measure of another dried fruit (best if they are chopped to size).
- Golden syrup can be substituted with equal measure of treacle or molasses
- 1 cup buttermilk = 1 cup fresh milk + 2 teaspoons vinegar or lemon juice.
- Milk can be substituted with soy milk. It can sometimes also be replaced with fruit juice acting as the liquid component.
- 7g dry yeast (1 sachet) = 15g compressed yeast

Cookery Tips for Best Results

General tips

- Before starting any recipe carefully read it through from beginning to end.
- Ensure you have all ingredients and utensils before you start.
- Refrigerated ingredients such as butter, cream cheese and eggs should be at room temperature for best results (unless otherwise specified). Set these out ahead of time. If you forget to remove butter from the fridge, use the coarse side of a grater to grate the butter. This will assist the mixer and soften the butter faster.
- Always adjust the oven shelf to the desired position and then preheat oven to baking temperature recommended in the recipe. Get to know your oven. Most ovens have “hotspots” and it may be necessary to turn food or swap shelves during cooking. However, be aware that every time you open the oven, the temperature drops. Only open the oven if necessary and be sure to close the door quickly.
- Break eggs into a small bowl before adding to mixture. This eliminates the chance of contaminating mixture with shells or rotten eggs.
- All recipes have been carefully developed and tested, but should you find it necessary to alter the ingredients or tin, you must allow for a variation in cooking time. Always test for doneness in baked goods before removing from oven or other cooking appliance.
- During mixing, ingredients may splash to the sides of the bowl. Pause the mixer and use a rubber or plastic spatula to scrape the bowl. NEVER USE A KNIFE, METAL SPOON OR FORK, as these can damage the beater and bowl. A light scraping after the addition of each ingredient assists in achieving efficient mixing.

Tips for cakes, biscuits and slices

- When cooked, a cake should shrink slightly from the pan.
- When testing most cakes (not sponges, fruitcakes or cheesecakes), gently touch the surface; it should feel firm. At this stage, remove the cake from the oven and close the oven door to retain the heat. Insert a thin skewer into the deepest part of the cake. When cake is done, no uncooked mixture should adhere to it.
- Testing cake doneness should be done quickly. If the cake needs to be returned to the oven, the oven door should be open for minimal amount of time. Rapid temperature change may cause an undercooked cake to sink in the middle.
- For most types of biscuits, you can test if they are cooked by gently pushing the biscuit on the tray with your finger. If it moves without breaking, the biscuit is cooked.
- Do not over beat any mixture. Be careful that you only mix/blend mixtures for the specified time. When folding, do so until just combined. Over beating or mixing can cause toughness, close texture, excessive shrinkage or effect rising.
- Curdling can sometimes occur when adding eggs to a mixture. If this happens, continue with the recipe as it will come back together when the dry ingredients are added.
- If cakes begin to overbrown, cover the top loosely with foil to protect it from the top element of the oven.
- To obtain the greatest volume when beating egg whites, be sure the bowl and beater are completely clean and dry before use. The smallest amount of grease or water can prevent the whites from aerating.

Cookery Tips for Best Results continued

- The term “soft peaks” means that the egg white barely supports itself. When the head of the mixer is lifted, the egg white mixture will curl and may fall from the beater.
- The term “firm peaks” means that the egg white holds its shape. When the head of the mixer is lifted, the egg white mixture will remain pointy and firm.
- When making pavlova or other meringues, always use caster sugar as it dissolves much easier than other coarser sugars. Sugar should begin being added at soft peaks. If you wait until the egg whites reach firm peaks and are dry, it will take longer to dissolve the sugar.
- To test if sugar is dissolved, rub a small quantity of mixture between your fingertips. If it feels grainy, continue beating until smooth.
- In general, cakes should be cooled on a wire rack after the suggested standing time. The standing time is to prevent the freshly baked cake from splitting or cracking when removed from the pan.
- Fruit cakes and various other heavy cakes, such as mud cakes, are best cooled in the pan. Due to the weight of these cakes, turning out while still warm will cause them to split. Cooling in the pan also keeps them moist.
- Sponges should be removed from the pan as soon as they come out of the oven.
- Most biscuits are best cooled on the baking tray.

Making a Successful Dough

Yeast

Yeast is a raising agent used in dough. It is a microscopic living organism that grows rapidly in suitable warm, moist conditions. The yeast feeds on sugar and expels carbon dioxide which expands the gluten framework. When foaming yeast, the liquid should be warm; about 26°C. If the liquid is too cold it will retard the yeast growth. If it is too hot it will kill the yeast.

Preparing the yeast

For the dry yeast to be activated it needs to ferment. To do this, place warm liquid and sugar into a bowl. Add dry yeast and mix. Stand in a warm, draft-free place until mixture starts to foam or bubble. This process will take about 10 minutes.

Note: If dried yeast has not been stored properly, has been exposed to light, extreme heat, or is out of date, it may be dead or inactive and it will not ferment. If the yeast does not foam, your dough will not rise.

Preparing the dough

1. Insert dough hook (refer to page 6). Place the dry ingredients into the bowl and lock the bowl onto the base.
2. Turn the speed dial to low speed (1-4), and gradually add the liquid ingredients (including the pre-prepared yeast mixture) to the bowl. When the ingredients start to form a ball, stop the mixer and use a rubber or plastic spatula to scrape down the sides of the bowl if necessary.
3. Knead on low speed (1-4) (depending on the amount of dough) until smooth and elastic; for about 5-8 minutes.
4. Transfer dough to a large, well greased mixing bowl. Cover the bowl with a light cloth or plastic wrap and place it in a warm, draft-free area until the dough doubles in size.
5. Plunge fist into the centre of the risen dough to punch out excess air. Fold outer edges into the centre and turn dough out onto a lightly floured surface. Cut and shape dough to form buns, rolls or freeform loaves and place on prepared baking trays. Alternatively, place dough into prepared bread tins. For pizza dough, it is now ready to be rolled, topped and baked.
6. For the final rising of the bread dough, cover the shaped dough with a light cloth and place in a warm, draft-free area until doubled in size again. Glaze and bake.

Making a Successful Dough continued

Tips

To add interest to breads.

- Brush dough with a little milk and sprinkle loaves or buns with poppy, caraway or sesame seeds before baking.
- Sprinkle loaves with shredded cheese during the last few minutes of baking.
- Drizzle cooled, sweet tea rings or buns with icing, or dust with icing sugar before serving.

Glazes

Glazes may be brushed over the dough before, during or after baking.

For a shiny crust, brush with cream or evaporated milk before baking; or with warm sieved apricot jam after baking.

For a glossy crust, brush with beaten egg white before baking.

For a matt finish, brush with melted butter or margarine after baking.

Questions & Answers:

Q. My mixture seems a little dry and crumbly. Do I need to add more water?

A. Some flour tends to absorb or want more moisture/liquid, especially on warm or humid days. Add more water, a drop at a time, until you reach a smooth ball/dough.

Q. I added too much water and my dough is very sticky, what can I do?

A. If the dough is smooth without lumps, add a little flour at a time and knead the dough until it is smooth, soft to the touch and bounces back when pressed with the tip of your finger. Dough should not be sticky to touch.

Q. My yeast did not bubble or foam, why?

A. The yeast may be dead or inactive, in which case you will need to replace it. This occurs when the liquid added or the standing position was too hot or too cold. It can also be because the yeast is out of date. If the yeast does not foam, your dough will not rise.

Q. My dough did not rise, why?

A. If the yeast fermented properly, you may just need to place the bowl in a warmer position. Covering the bowl with plastic wrap, and ensuring the area is draft free may help. In winter, your dough will take longer to rise.

Recipes

Choc-Hazelnut Pancakes

4 cups plain flour
¾ cup caster sugar
3 ¾ cups buttermilk
3 eggs
Butter, for frying
Hazelnut spread, to serve

1. Place the flour, sugar, buttermilk and eggs in the Stainless Steel Mixing Bowl. Using the Whisk, mix on low speed (1-4) until combined. Increase to medium speed (5-7) and mix until smooth.
2. Heat a large non-stick frying pan on medium heat. Lightly grease with a little butter. Spoon ⅓ cup of the mixture into the pan and tilt pan to form a circle. Cook until bubbles begin to appear on the surface. Flip pancake and cook for a further minute. Repeat with remaining batter.
3. Serve pancakes with hazelnut spread, whipped cream and roasted hazelnuts.

Basic Cookie Dough

500g butter, room temperature, chopped
1 ½ cups icing sugar
2 teaspoons vanilla essence
4 cups plain flour
1 cup custard powder
⅓ cup milk

1. Preheat oven to moderate (180°C/160°C fan-forced). Grease and line baking trays.
2. Place butter, sugar and vanilla in the Stainless Steel Mixing Bowl. Using the Beater, mix on medium speed (5-7) until smooth and creamy.
3. Add flour, custard powder and milk. Mix on low speed (1-4) until combined.
4. Divide dough in half. Wrap in plastic and refrigerate for 30 minutes.
5. Roll each portion of dough between 2 sheets of baking paper to 5mm thick. Use a 5cm round cutter to cut rounds from dough. Place cookies on prepared trays and bake for about 10-12 minutes swapping trays halfway through cooking. Cool on trays.

Variations:

Orange and poppy seed cookies – Replace the vanilla essence with 2 teaspoons of orange juice, 1 teaspoon of orange rind and 1 tablespoon of poppy seeds.

Choc chip cookies – Add 1 cup of choc chips in with the flour. Don't roll dough, but roll 1 tablespoons of the cookie dough mixture into balls and slightly flatten onto the trays.

Recipes continued

Lemon Slice

125g butter, room temperature

1 ¼ cups icing sugar mixture

1 ¼ cups plain flour

3 eggs

1 cup caster sugar

1 teaspoon finely grated lemon rind

½ cup lemon juice

1. Preheat oven to moderate (180°C/160°C fan-forced). Grease and line a 23cm square pan with baking paper, extended 2cm above the edge of the pan.
2. Place butter and icing sugar in the Stainless Steel Mixing Bowl. Using the Scrapemaster™ spatula beater, beat on medium speed (5-7) for 1 minute or until smooth and creamy. Add 1 cup of the flour and mix on low speed (1) until just combined.
3. Press mixture evenly over the base of prepared pan. Bake for about 15 minutes or until browned lightly.
4. Meanwhile, place eggs, caster sugar, remaining flour, rind and juice in the Stainless Steel Mixing Bowl. Using the Whisk, mix on medium speed (5-7) until combined. Pour egg mixture over hot base.
5. Bake for about 20 minutes or until firm. Cool in pan.

Honey, Cranberry and Pistachio Nougat

2 sheets edible rice paper

½ cup honey

2 ½ cups caster sugar

⅓ cup water

500g liquid glucose

2 egg whites, room temperature

1 ½ cups pistachios, toasted

½ cup raisins (dried cranberries)

1. Lightly grease a 20cm square cake pan. Line the base of the pan with 1 sheet of rice paper, trimming to fit.
2. Combine honey, sugar, water and glucose in a medium saucepan. Stir over medium heat, without boiling, until sugar dissolves. Bring to boil. Do not stir after this point. Using a candy thermometer, cook until mixture reaches 140°C. Immediately remove from heat.
3. Using the Whisk, beat egg whites on very high speed (11-12) until firm peaks form. Reduce to medium speed (5-7) and slowly add the sugar syrup in a thin, steady stream. Once all the sugar syrup has been added, continue beating for a further minute. Add the pistachios and cranberries and stir to combine.
4. Quickly spoon into prepared pan, using a spatula to scrape the bowl. A spoon dipped in hot water will help you spread the nougat quickly. Top with the remaining sheet of rice paper and gently press to flatten.
5. Set aside to cool at room temperature for about 6 hours or until set. Remove from pan and cut into small squares to serve.

Recipes continued

Coconut Marshmallows

- 1/3 cup gelatine
 - 1 cup cold water
 - 2 cups hot water
 - 4 cups caster sugar
 - 2 teaspoons lemon juice
 - 2 cups shredded coconut, lightly toasted
1. Combine gelatine and 1 cup of cold water. Stand for 5 minutes
 2. Stir sugar and 2 cups of hot water in a large saucepan over low heat until sugar dissolves. Bring to boil. Add gelatine mixture; simmer, uncovered for 20 minutes. Cool to room temperature.
 3. Transfer sugar mixture to the Stainless Steel Mixing Bowl. Add juice. Using the Whisk, begin beating on low speed (1). Gradually increase to very high speed (12) over 15 minutes. Mixture should be very thick and hold its shape.
 4. Rinse a 20cm x 30cm lamington pan with cold water; do not dry. Spread marshmallow mixture into pan. Sprinkle with enough coconut to cover the surface. Allow to set at room temperature for 2 hours or until firm.
 5. Cut marshmallow into squares using a wet knife; toss in remaining coconut.

Sweet Brioche

Makes: 8

- 1/4 cup luke-warm milk
 - 2 teaspoons (7g sachet) dry yeast
 - 1/4 cup caster sugar
 - 2 1/4 cups plain flour,
 - 1 teaspoons ground cinnamon
 - 1 teaspoon salt
 - 3 eggs
 - 125g butter, room temperature, cut into cubes
 - Approximately 1/3 cup plain flour, extra
 - 1/2 cup sultanas
 - 1 egg yolk, lightly whisked
 - 1 tablespoon caster sugar, extra
1. Combine the milk, yeast and 1/2 teaspoon of the sugar in a small bowl. Set aside in a warm place for about 10 minutes or until frothy.
 2. Place remaining sugar, flour, cinnamon and salt in the Stainless Steel Mixing Bowl. Add yeast mixture and eggs.
 3. Using the Dough Hook, knead on low speed (2) for about 1 minute or until combined. Continue kneading for a further 5 minutes.
 4. Add 2-3 pieces of butter to dough mixture and continue kneading, adding a little butter at a time until well incorporated. If dough begins to lose its "ball" shape, add as much of the extra flour as necessary to keep it combined. Knead in the sultanas. This step should take a total of 4 minutes.
 5. Remove dough from bowl; wash and dry bowl, then return dough to bowl. Cover; set aside in a warm, draft-free place for about 1 hour or until doubled in size.

Recipes continued

6. Preheat oven to moderately hot (200°C/180°C fan-forced). Line 2 oven trays with baking paper.
7. Plunge your fist into the dough and using the Dough Hook, knead again on low speed (2) for 1 minute or until smooth.
8. Divide dough into 8 even portions. Work each dough portion into a smooth ball and place on prepared trays. Set aside in a warm, draft-free place for 30 minutes.
9. Brush each brioche with egg yolk and sprinkle with extra sugar. Bake for 15 minutes or until golden and cooked through.

Orange Drops

Makes: About 40

- 185g butter, room temperature
- 1 cup caster sugar
- 1 teaspoon finely grated orange rind
- 1 egg
- 2 cups plain flour
- ½ teaspoon baking powder
- ½ cup breakfast marmalade

1. Preheat oven to moderate (180°C/160°C fan-forced). Grease and line oven trays with baking paper.
2. Using the Beater, mix butter, sugar and orange rind on medium speed (5-7) for about 2 minutes or until creamy. Add egg and mix well.
3. Add the flour and baking powder and mix on low speed (1-4) for about 30 seconds or until combined.
4. Roll 2 teaspoons of the mixture into balls, flatten slightly and place on prepared trays. Press your finger into the middle of each ball to make an indent. Spoon ½ teaspoon of marmalade into each indent.
5. Bake for 10 minutes or until cooked. Remove from oven. Cool on wire racks.

Recipes continued

Golden Syrup and Walnut Scrolls

Makes: 12

- 2 ¼ cups self-raising flour
- 1 tablespoon caster sugar
- 100g butter, chopped
- ⅔ cup milk
- 1 egg
- 1 cup walnuts, chopped
- ½ cup slivered almonds
- ⅓ cup firmly packed brown sugar
- 1 teaspoon ground cinnamon
- ¼ cup golden syrup

1. Preheat oven to moderately hot (200°C/180°C fan-forced). Lightly grease a 19cm x 29cm slice pan.
2. Using the Scrapemaster™ spatula beater, mix flour, sugar and half of the butter on low speed (1-4) until combined.
3. Add milk and egg. Using the Dough Hook, knead on low speed (1-4) to form a soft sticky dough. Knead for a further 1 minute.
4. Turn onto a clean, floured bench and roll dough into a 30cm x 40cm rectangle. Sprinkle with walnuts, almonds, brown sugar and cinnamon. Dot with remaining butter. Roll dough tightly from the long side to form a log. Trim ends and cut into 12 even slices.
5. Place slices, cut side up into prepared pan. Bake for about 25 minutes or until golden, turning halfway through cooking. Remove from pan and drizzle with golden syrup. Serve warm.

Apple Tea Cake

- 125g butter, room temperature
- 1 teaspoon vanilla vanilla
- ½ cup brown sugar
- 2 eggs
- 1 ½ cups plain flour
- ⅓ cup milk
- 2 green apples, peeled, cored, thinly sliced
- 2 teaspoons raw sugar
- ½ teaspoon cinnamon
- ¼ cup apricot jam, warmed

1. Preheat oven to moderately slow (160°C/140°C fan-forced). Grease and line a 22cm round spring form tin with baking paper.
2. Using the Beater, mix butter, vanilla and sugar until creamy. Gradually add the eggs and beat well. Add the flour and milk. Mix on low speed (1-4) until combined. Spoon mixture into prepared pan.
3. Arrange apples over cake mixture. Sprinkle with raw sugar and cinnamon. Bake for 50 minutes. Remove from oven, brush with warm jam and bake for a further 10 minutes or until cooked when tested. Serve with whipped cream.

Recipes continued

Cheats Tiramisu

- 1 ¼ cups espresso
 - 2 tablespoons caster sugar
 - ¼ cup coffee flavoured liqueur (Tia Maria or Kahlua)
 - 600mls thickened cream
 - ¼ cup icing sugar mixture
 - 2 teaspoons vanilla essence
 - 250g sponge finger biscuits
 - 50g dark chocolate, grated
1. Combine coffee, caster sugar and liqueur in a bowl. Cool.
 2. Place cream, icing sugar and vanilla in the Stainless Steel Mixing Bowl. Using the Whisk, whip on very high speed (11-12) until soft peaks form.
 3. Dip one sponge finger into cooled coffee mixture. Remove from liquid and spread one side with a little cream. Place sideways in an 8-cup capacity serving dish. Dip a second sponge finger in coffee mixture, spread with a little cream and lay next to the first. Repeat with remaining sponge fingers, coffee mixture and cream. If there is any remaining coffee mixture once all the biscuits have been dipped, pour this over the biscuits.
 4. Spread top with remaining cream and smooth surface. Sprinkle with chocolate; cover and refrigerate overnight.

Upside Down Pear and Almond Cake

- ½ cup slivered almonds
 - 1 ¼ cups firmly packed brown sugar
 - 1 large pear, peeled, cored, thinly sliced
 - 185g butter, room temperature
 - 3 eggs
 - ¼ cup plain flour
 - 1 ¾ cups almond meal
1. Preheat oven to moderately hot (200°C/180°C fan-forced). Grease and line a 22cm round cake pan with baking paper.
 2. Sprinkle the almonds and ¼ cup of the sugar over the base of the pan. Evenly top with pear slices.
 3. Using the Beater, beat butter and remaining sugar on medium speed (5-7) for about 3 minutes or until light and fluffy. Beat in eggs one at a time. Add flour and almond meal and mix on low speed (1-4) until combined.
 4. Pour mixture into pan. Bake for about 35 minutes or until cooked when tested. Stand for 10 minutes before turning upside down onto a wire rack. Serve warm or cold with whipped cream.

Recipes continued

White Chocolate Layered Butter Cake

185g butter, room temperature
1 ½ teaspoons vanilla essence
1 ¾ cups caster sugar
4 eggs
1 ½ cups plain flour
¾ cup self-raising flour
2 teaspoons cocoa powder
¾ teaspoon bicarbonate soda
¾ cup milk

1. Preheat oven to moderately slow (160°C/140°C fan-forced). Grease and line a deep, 20cm round cake pan, extending the baking paper 3cm above the rim of the pan.
2. Place ingredients in the Stainless Steel Mixing Bowl. Using the Scrapemaster™ spatula beater, mix on low speed (1) for about 30 seconds or until just combined. Increase to low speed (4) and beat for 1 minute. Pour mixture into prepared pan.
3. Bake for about 1 ½ hours or until cooked when tested with a skewer. Stand in pan for 5 minutes before turning onto a wire rack to cool.
4. When cool, split cake horizontally into 3 even sized disks. Layer and cover with white chocolate ganache. Top with fresh berries and chocolate curls to decorate.

White Chocolate Ganache

1 cup thickened cream
600g white chocolate, chopped

1. Bring cream to boil in a medium saucepan and immediately remove from heat.
2. Stir through chocolate until melted. Cover; refrigerate, stirring occasionally until spreadable consistency.

Chocolate Chocoholic Cake

1 ½ cups water
2 ¼ cups caster sugar
185g butter, room temperature
¼ cup cocoa powder
¾ teaspoon bicarbonate of soda
2 ¼ cups self-raising flour
3 eggs

1. Preheat oven to moderate (180°C/160°C fan-forced). Grease and line a 22cm square cake pan with baking paper.
2. Combine water, sugar, butter, cocoa and soda in a large saucepan. Stir over heat without boiling until sugar dissolves and butter is melted. Bring to boil then reduce heat to low. Simmer uncovered for 4 minutes being careful the saucepan doesn't overflow. Transfer to the Stainless Steel Mixing Bowl; cool to room temperature.
3. Add flour to the bowl. Using the Scrapemaster™ spatula beater, beat on low speed (1) until combined. Add eggs and beat on low speed (4) until combined. Pour mixture into prepared pan.
4. Bake for about 1 hour or until cooked when tested. Stand in pan for 5 minutes before turning onto a wire rack to cool. Top with rich fudge frosting.

Recipes continued

Rich fudge frosting

90g butter

⅓ cup water

½ cup caster sugar

1 ½ cups icing sugar mixture

⅓ cup cocoa powder

1. Combine the butter, water, caster sugar in a small saucepan. Stir over low heat without boiling until sugar dissolves. Sift icing sugar and cocoa into a bowl, then gradually stir in hot butter mixture. Cover then refrigerate for about 20 minutes or until frosting is cool and thickens. Beat with a wooden spoon until spreadable.

Ricotta Baked Cheesecake

90g butter, room temperature

¼ cup caster sugar

1 egg

1 ¼ cups plain flour

¼ cup self-raising flour

750g fresh ricotta

1 cup caster sugar, extra

5 eggs, extra

3 teaspoons finely grated lemon rind

1 tablespoon lemon juice

1. Grease a 22cm springform tin and line the base with baking paper.
2. Using the Scrapemaster™ spatula beater, beat butter, sugar and egg on low speed (4) until combined.
3. Add flours and beat on low speed (1) until combined. Using the back of a spoon, press mixture over the base of prepared tin. Refrigerate for 30 minutes.
4. Preheat oven to moderately hot (200°C/180°C fan-forced). Bake for 15 minutes. Remove from oven and press base down with a clean tea towel. Cool.
5. Reduce oven temperature to moderately slow (160°C/140°C fan-forced).
6. Place ricotta, extra sugar, extra eggs, rind and juice in the Stainless Steel Mixing Bowl. Using the Whisk, mix on high speed (8-10) until smooth.
7. Pour into tin and bake for about 1 hour or until set but still wobbly in the centre. Turn the oven off. Cool cake in the oven with the door ajar. Refrigerate for several hours before serving dusted with icing sugar.

Recipes continued

Macadamia Meringue Cake

6 egg whites

Pinch salt

1 ½ cups caster sugar

1 teaspoon vanilla essence

1 teaspoon white vinegar

Filling

300mls pure cream

1 teaspoon vanilla essence

½ cup icing sugar

250g marscapone cheese

100g roasted macadamias, chopped

1. Preheat oven to very slow (120°C/100°C fan-forced).
2. Grease and line 2 oven trays with baking paper. Mark a 22cm circle on each tray.
3. Using the Whisk, beat egg whites and salt on very high speed (11-12) until soft peaks form.
4. Add sugar, a small amount at a time, whisking until thick and glossy. Add vanilla and vinegar and whisk until just combined.
5. Divide the mixture evenly between prepared trays. Spread evenly onto marked circles.
6. Bake for about 1 ½ hrs or until firm and slightly browned. Turn off oven. Cool meringues completely in the oven with the door ajar.
7. To make filling, use the Whisk attachment to whip cream, vanilla and icing sugar on high speed (11-12). Stir through marscapone and macadamias.
8. To assemble, sandwich meringue disks together with cream mixture. Dust with icing sugar and top with fresh berries.

Jam Scone Ring

2 cups self-raising flour

1 tablespoon caster sugar

30g butter, room temperature

¾ cup milk

1 egg yolk

2 tablespoons apricot jam, warmed

½ cup finely chopped dried apricots

1. Preheat oven to moderately hot (200°C/180°C fan-forced). Grease and line an oven tray with baking paper.
2. Using the Scrapemaster™ spatula beater, mix flour, sugar and butter on low speed (2) until combined.
3. Add milk and egg yolk. Using the Dough Hook, knead on low speed (2) to form a soft sticky dough.
4. Turn onto a clean, floured bench and roll dough into a 30cm x 40cm rectangle. Spread jam over dough and scatter with apricots. Roll dough from the long side to form a log. Place on the prepared tray and curve to form a ring. Press ends together to seal.
5. Bake for about 25-30 minutes or until cooked. Serve warm, dusted with sifted icing sugar.

Recipes continued

Sticky Toffee Pudding

200g pitted dates, chopped

1 ½ teaspoons baking powder

½ cup boiling water

125g butter, room temperature

1 cup firmly packed brown sugar

2 eggs

1 ½ cups plain flour

¼ cup milk

1. Place the dates, baking powder and boiling water in a bowl. Set aside for 10 minutes.
2. Preheat oven to moderate (180°C/160°C fan-forced). Grease and line a 20cm square cake pan with baking paper.
3. Using the Scrapemaster™ spatula beater, mix the butter and sugar on medium speed (5-7) for about 2 minutes or until creamy. Gradually add the eggs and beat well. Add the flour, milk and date mixture. Mix on medium speed (5-7) until just combined.
4. Spoon mixture into prepared pan and bake for 40 minutes or until cooked when tested.
5. Serve pudding with warm toffee sauce (see following recipe).

Toffee Sauce

200g butter

1 cup pure cream

1 cup firmly packed brown sugar

1. Place all ingredients in a small saucepan. Stir over medium heat until melted and combined. Simmer for 3 minutes.

Lemon Thyme and Cheese Focaccia **Makes: 2**

200mls luke-warm water

½ teaspoon caster sugar

2 teaspoons (7g sachet) dry yeast

2 cups plain flour

1 teaspoon salt

1 ½ tablespoons (30mls) olive oil

1 tablespoon finely chopped fresh lemon thyme

½ cup grated cheddar cheese

1 tablespoon milk

Sea Salt flakes

1. Combine the water, sugar and yeast in a jug; stir to combine. Cover mixture and place in a warm area for about 10 minutes until the mixture is frothy.
2. Place the flour and salt in the Stainless Steel Mixing Bowl. Add the yeast mixture and olive oil. Using the Dough Hook, mix on low speed (1-2) for about 2 minutes or until combined and mixture forms a ball. Continue kneading for 8 minutes.
3. Remove dough from the bowl. Lightly grease the bowl and return dough. Cover; allow to rise in a warm area for about 1 hour or until doubled in size.
4. Preheat oven to moderately hot (200°C/180°C fan-forced). Grease and line 2 oven trays with baking paper.
5. Punch the dough with your fist to knock out the air. Cut the dough in half. Roll each piece on a lightly floured surface into a 20 x 25cm rectangle. Place on prepared trays. Sprinkle thyme and cheese over each focaccia, leaving a 1cm border. Brush borders with a little water, then fold in half to make 2 long rectangles. Press edges

Recipes continued

together, score 3 times across the top.
Brush with milk and sprinkle with sea salt.

6. Bake for 15-20 minutes or until cooked through. Serve warm, cut into pieces.

Cheesy Spinach Scrolls

Makes: 12

2 cups self-raising flour

1 tablespoon caster sugar

50g butter, chopped

$\frac{3}{4}$ cup milk

250g frozen spinach, thawed, excess moisture removed

1 cup pizza cheese

100g feta cheese, crumbled

1. Preheat oven to moderately hot (200°C/180°C fan-forced). Lightly grease and line a 22cm square cake pan.
2. Using the Scrapemaster™ spatula beater, mix flour, sugar and butter on speed 2 for about 2 minutes or until combined.
3. Add milk and using the Dough Hook, knead on speed 2 for about 1 minute or until a soft sticky dough is formed.
4. Turn onto a clean, floured bench and roll dough into a 30cm x 40cm rectangle. Squeeze excess moisture from spinach with your hands. Chop coarsely and pat dry with absorbent paper towel. Sprinkle pizza cheese, spinach and feta over dough. Roll tightly from the long side. Trim ends and cut into 12 even slices.
5. Place scrolls, cut-side up in prepared pan. Bake for about 25 minutes or until cooked through. Serve warm.

Basic Pizza Dough

Makes: 2 large pizzas

150ml luke-warm water

1 teaspoon caster sugar

2 teaspoons (7g sachet) dry yeast

2 cups plain flour

$\frac{1}{2}$ teaspoon salt

2 tablespoon olive oil

1. Combine the water, sugar and yeast in a jug; stir to combine. Cover mixture and place in a warm area for about 10 minutes until the mixture is frothy.
2. Place the flour and salt in the Stainless Steel Mixing Bowl. Add the yeast mixture and olive oil. Using the Dough Hook, mix on low speed (1-2) for about 2 minutes or until combined and mixture forms a ball. Continue to knead on low speed (1-2) for a further 8 minutes.
3. Remove dough from the bowl. Lightly grease the bowl and return dough. Cover; allow to rise in a warm area for about 1 hour or until doubled in size.
4. Punch the dough with your fist to knock out the air. Cut the dough in half. Take one piece and roll on a lightly floured surface into a rough round. Place on a lightly greased pizza tray and stretch the dough to fit the tray. Repeat with remaining dough. Cover; allow to stand for 20-30 minutes. Top as desired.

Tip: if you prefer a thick pizza crust, use this dough quantity to make 1 pizza instead.

Recipes continued

Supreme Pizza

Makes: 2 large pizzas

- 1 quantity basic pizza dough
- ¼ cup pizza sauce
- 2 cups pizza cheese
- ¼ cup finely chopped fresh basil
- ½ red onion, thinly sliced
- 1 small red capsicum, thinly sliced
- 100g button mushrooms, thinly sliced
- 100g shaved ham, torn
- ¼ cup pitted kalamatta olives

1. Prepare basic pizza dough according to recipe.
2. Preheat oven to very hot (240°C/220°C fan-forced).
3. Spread pizza sauce over bases. Sprinkle with half of the cheese. Top with remaining ingredients and sprinkle with remaining cheese.
4. Cook pizza, for about 15 minutes or until bases are golden and cheese has melted.

Potato and Rosemary Pizza

Makes: 2 large pizzas

- 1 quantity basic pizza dough
- 1 tablespoon olive oil
- 1 clove garlic, crushed
- Salt and pepper, to taste
- 2 cups pizza cheese
- 200g new potatoes, very thinly sliced
- 1 tablespoon finely chopped fresh rosemary

1. Prepare basic pizza dough according to recipe.
2. Preheat oven to very hot (240°C/220°C fan-forced).
3. Combine olive oil and garlic in a small bowl. Using the back of a spoon, spread oil mixture evenly over pizza bases. Season with salt and pepper.
4. Sprinkle bases with half of the cheese. Top with potato slices and rosemary. Sprinkle with remaining cheese.
5. Cook pizza, for about 15 minutes or until bases are golden and cheese has melted.

Tip: Use a mandolin or V-slice to cut potato very thinly. Potatoes may not cook if not cut thin enough. If you can't cut the potatoes very thinly, you may need to par-cook them in the microwave before placing on the pizza.

Recipes continued

Gourmet Vegetarian Pizza

Makes: 2 large pizzas

- 1 quantity basic pizza dough
- ¼ cup pizza sauce
- 2 cups pizza cheese
- ¼ cup finely chopped fresh basil
- ½ red onion, thinly sliced
- ½ cup bottled char-grilled capsicum, drained, chopped
- 100g button mushrooms, thinly sliced
- ½ cup sun-dried tomatoes, drained, chopped
- ¼ cup pitted kalamatta olives

1. Prepare basic pizza dough according to recipe.
2. Preheat oven to very hot (240°C/220°C fan-forced).
3. Spread pizza sauce over bases. Sprinkle with half of the cheese. Top with remaining ingredients and sprinkle with remaining cheese.
4. Cook pizza, for about 15 minutes or until bases are golden and cheese has melted.

Traditional Pasta Dough

- 2 cups plain flour
- 2 large eggs, lightly beaten
- 3 tablespoons water
- 1 tablespoon olive oil

1. Place ingredients in mixing bowl in listed order. Using the dough hook attachment mix on Speed 1 for 2 minutes or until combined. The dough should be smooth and soft. If sticky add a tablespoon of flour at a time. Continue to knead the dough for a further 1 minute.
2. Remove dough from bowl. Wrap in cling wrap and refrigerate for at least 1 hour. Roll into desired shape.

Variation: Herb Pasta - Add ¼ cup of your favourite chopped herbs at step one.

Recipes continued

Traditional Spaghetti

1 qty of traditional pasta dough
extra flour

1. Using the pasta roller, roll out the dough to the desired thickness of the spaghetti according to the guide below.
2. Flour the spaghetti roller generously with flour as well as the pasta sheet.
3. Feed the pasta sheet through the spaghetti roller and hang over rods to dry.

THICK SPAGHETTI -
roll dough to thickness 5

MEDIUM SPAGHETTI -
roll dough to thickness 7

ANGEL HAIR SPAGHETTI -
roll dough to thickness 9

Traditional Tagliatelle

1 qty of traditional pasta dough
extra flour

1. Using the pasta roller, roll out the pasta to thickness number 8.
2. Generously flour the Tagliatelle roller and the pasta sheet.
3. Feed the pasta sheet through the Tagliatelle roller and hang over rods to dry.

Wholegrain Pasta Dough

1 cup plain flour
1 cup whole grain flour
2 eggs, lightly beaten
¼ cup olive oil
¼ cup water

1. Place flours in the mixing bowl. Using the dough hook attachment process on Speed 1 for 15 seconds or until combined.
2. Add remaining ingredients to the bowl. Continue to mix on Speed 2 until dough forms a ball, about 2 minutes. The dough should be smooth and soft. If sticky add a tablespoon of flour at a time. Continue to knead the dough for a further 1 minute on Speed 2.
3. Remove dough from bowl. Wrap in cling wrap and refrigerate for at least 1 hour. Roll into desired shape.

Recipes continued

Roasted Capsicum Pasta Dough

200g chargrilled red capsicum, drained

2 ½ cups plain flour

1 teaspoon olive oil

1 teaspoon salt

2 eggs, lightly beaten

1 egg yolk, lightly beaten

1. Place capsicum in the bowl of a food processor. Process until a smooth paste.
2. Place all ingredients, including capsicum, in mixing bowl in listed order. Using the dough hook attachment mix on Speed 1 for 2 minutes or until combined. If sticky add a tablespoon of flour at a time. Continue to knead the dough for a further 1 minute.
3. Remove dough from bowl. Wrap in cling wrap and refrigerate for at least 1 hour. Roll into desired shape.

Spinach Pasta Dough

The drier the spinach the better the pasta dough will be.

200g frozen spinach, defrosted, well drained

2 ½ cups plain flour

1 teaspoons salt

2 large eggs, lightly beaten

1 egg yolk

1. Place spinach in the bowl of a food processor. Process until a smooth paste.
2. Place all ingredients, including spinach, in mixing bowl in listed order. Using the dough hook attachment mix on Speed 1 for 2 minutes or until combined. If sticky add a tablespoon of flour at a time. Continue to knead the dough for a further 1 minute.
3. Remove dough from bowl. Wrap in cling wrap and refrigerate for at least 1 hour. Roll into desired shape.

Recipes continued

Cherry Tomato, Eggplant and Chorizo Pasta

Serves: 3-4

- 1 quantity traditional spaghetti
- 2 tablespoons olive oil
- 500g chorizo sausage, roughly chopped
- 400g cherry tomatoes, halved
- 2 cloves garlic, crushed
- 1 eggplant, cubed
- 1 red onion, finely sliced
- 1 teaspoon dried chilli flakes
- ½ cup roughly chopped flat-leaf parsley
- 2 tablespoons lemon juice
- Salt and freshly ground black pepper, to taste

1. Fill a large saucepan with water, bring to the boil.
2. Heat oil in a large frypan over high heat. Add chorizo and cook for 2 minutes or until browned. Add tomatoes, garlic, eggplant, onion and chilli. Cook for a further 5 minutes or until tomatoes have burst and eggplant is tender.
3. Place spaghetti in boiling water. Cook for 3-4 minutes or until just tender. Drain.
4. Place spaghetti into sauce and toss to combine. Add parsley and lemon. Season to taste with salt and pepper. Serve.

Oven Roasted Cherry Tomatoes, Garlic, Thyme and Crunchy Sourdough Crumbs

This recipe is great with the addition of chicken.

Serves: 3-4

- 1 quantity traditional spaghetti
- 500g cherry tomatoes
- 4 cloves garlic, halved
- 4 sprigs fresh thyme
- 4 tablespoons olive oil
- 4 thick slices sourdough bread
- Salt and freshly ground black pepper, to taste
- Olive oil, to garnish

1. Preheat oven to 180°C. Line a baking tray with baking paper.
2. Place tomatoes, garlic and thyme on prepared baking tray. Drizzle with half of the oil. Season with salt and pepper.
3. Bake for 30-35 minutes or until tomatoes are golden and blistered.
4. Meanwhile, using a food processor process bread until a medium crumb. Place on a baking tray and drizzle with remaining oil. Place in oven and bake for 10 minutes or until golden brown.
5. Fill a large saucepan with water, bring to the boil.
6. Place spaghetti in boiling water. Cook for 3-4 minutes or until just tender. Drain.
7. Combine spaghetti, tomatoes, bread crumbs and seasoning in a bowl, toss to combine.

Recipes continued

White Wine Clam and Mussel Spaghetti

Serves: 3-4

- 1 quantity traditional spaghetti
- 2 tablespoons olive oil
- 3 cloves garlic, crushed
- 2 onions, finely chopped
- ¼ cup tomato paste
- 1 cup white wine
- ¼ cup vermouth
- 2 x 400g cans cherry tomatoes
- 500g clams, cleaned, beards removed
- 500g small black mussels, cleaned, beards removed
- ¼ cup chopped fresh flat-leaf parsley
- Salt and freshly ground black pepper, to taste

1. Fill a large saucepan with water, bring to the boil.
2. Heat oil in a large saucepan over medium heat. Add onion and garlic. Cook for 3-4 minutes or until tender. Add tomato paste and cook for a further 2 minutes. Add wine and vermouth, cooking until reduced by half.
3. Add cherry tomatoes to the pan and cook for 10 minutes or until thickened.
4. Add clams and mussels to the pan. Cover. Cook for 3-4 minutes or until all the shells are open. Discard any that remain closed.
5. Place spaghetti in boiling water. Cook for 3-4 minutes or until just tender. Reserve 2-3 tablespoons of pasta water. Drain. Set aside.
6. Toss spaghetti and reserved spaghetti liquid in the sauce. Season to taste with salt and pepper. Garnish with parsley. Serve.

Pumpkin Pasta Dough

- 2 ¼ cups plain flour
 - ½ cup cooked pumpkin, pureed
 - 1 teaspoon olive oil
 - 1 teaspoon salt
 - 2 eggs, lightly beaten
1. Place all ingredients in mixing bowl in listed order. Using the dough hook attachment mix on Speed 1 for 2 minutes or until combined. If sticky add a tablespoon of flour at a time. Continue to knead the dough for a further 1 minute.
 2. Remove dough from bowl. Wrap in cling wrap and refrigerate for at least 1 hour. Roll into desired shape.

Recipes continued

Pumpkin, Walnut, Rocket and Burnt Butter Tagliatelle

Serves: 3-4

- 1 quantity pumpkin tagliatelle
 - 500g butternut pumpkin, peeled, cut into 2cm cubes
 - 2 tablespoons olive oil
 - 120g butter, cubed
 - ½ cup walnuts, halved
 - 200g rocket
 - Salt and freshly ground black pepper, to taste
1. Preheat oven to 180°C. Line a baking tray with baking paper.
 2. Spread pumpkin over prepared baking tray and drizzle with oil. Bake for 30 minutes or until soft and golden brown.
 3. Fill a large saucepan with water, bring to the boil.
 4. Place tagliatelle in boiling water. Cook for 3-4 minutes or until just tender. Drain. Set aside.
 5. Melt butter in a medium frypan over medium heat. Allow butter to foam and turn a light golden colour. Add walnuts. Cook butter for a further 30 seconds before removing from the heat.
 6. In a large bowl combine pumpkin, pasta, walnut mixture and rocket. Season to taste with salt and pepper. Serve.

Slow Roasted Pork Ragu in Red Wine over Tagliatelle

Serves: 4-6

- 1 quantity traditional tagliatelle
 - 1.5kg pork shoulder, on the bone
 - 2 x 400g cans chopped tomatoes
 - 5 cloves garlic, roughly chopped
 - 3 onions, roughly chopped
 - 2 tablespoons olive oil
 - 1 ½ cups red wine
 - 2 cups chicken stock
 - 10 tomatoes, halved
 - 1 tablespoon balsamic vinegar
 - 1 tablespoon lemon zest
 - 1 cup roughly chopped fresh basil
 - 2 tablespoons chopped fresh oregano
 - Salt and freshly ground black pepper, to taste
 - Grated parmesan cheese, to serve
1. Preheat oven to 160°C.
 2. In a large roasting pan add pork, chopped tomatoes, garlic, onions and olive oil. Add the stock and half of the wine, season well. Season heavily with salt and pepper. Place in oven and cook for 2 hours, turning occasionally.
 3. After 2 hours add tomatoes to the pan. Return to oven and cook for a further hour.
 4. Remove pork from pan. Using two forks gently tear the pork into bite sized pieces. Pour remaining sauce into a blender and process until smooth.
 5. Pour sauce into a medium saucepan and heat over medium heat. Add balsamic vinegar, remaining wine and lemon. Bring to a simmer and cook for 15 minutes.

Recipes continued

6. Fill a large saucepan with water, bring to the boil.
7. Place pasta in boiling water. Cook for 3-4 minutes or until just tender, drain and set aside.
8. Toss pasta through pork mixture with basil and oregano. Season to taste with salt and pepper. Garnish with parmesan cheese.

Tagliatelle with Spinach, Mascarpone and Parmesan

Serves: 3-4

- 1 quantity spinach tagliatelle
- 1 tablespoon olive oil
- 30g butter
- 2 cloves garlic, crushed
- 1 onion, finely chopped
- ½ teaspoon grated nutmeg
- 150g baby spinach leaves
- ½ cup thickened cream
- 150g mascarpone cheese
- 1 cup grated parmesan cheese
- 1 teaspoon lemon zest
- Salt and freshly ground black pepper, to taste

1. Heat oil and butter in a medium saucepan over medium heat. Add onion and garlic cook for 3-4 minutes or until tender. Add nutmeg and spinach. Stir until spinach has wilted and halved in size.
2. Add cream, mascarpone, parmesan and lemon zest to the pan. Bring to a simmer. Set aside.
3. Fill a large saucepan with water, bring to the boil.
4. Place tagliatelle in boiling water. Cook for 3-4 minutes or until just tender. Drain.
5. Toss pasta through spinach mixture. Season to taste with salt and pepper. Serve.

Recipes continued

Pumpkin Ravioli with Oregano and Hazelnut Pesto

Serves: 4-6

PESTO:

- 1 ½ cups fresh oregano
- ½ cup olive oil
- ½ cup fresh basil
- ½ cup grated parmesan cheese
- ⅓ cup toasted hazelnuts
- 2 cloves garlic
- Salt and freshly ground black pepper, to taste

RAVIOLI:

- 1 recipe pumpkin pasta, rolled into Lasagne sheets
- 1 kg butternut pumpkin, peeled, chopped into large pieces
- 4 cloves garlic
- 2 tablespoons olive oil
- 80g butter
- 1 cup grated parmesan cheese
- 2 tablespoons finely chopped fresh oregano
- 2 tablespoons finely chopped fresh sage
- 1 teaspoon ground nutmeg
- Salt and freshly ground black pepper, to taste
- 1 egg, lightly beaten
- 4 sheets of rolled pasta to thickness number 8
- Fresh sage, to garnish

1. Preheat oven to 200°C. Line a baking tray with baking paper.
2. Pesto: In a food processor, process all ingredients until a chunky paste. Season to taste with salt and pepper. Set aside.

3. Ravioli: Place pumpkin and garlic on prepared baking tray. Drizzle with olive oil. Bake for 30-40 minutes or until pumpkin is tender. Set aside to cool.
4. Melt butter in a small pan over medium-high heat. Allow to foam and turn to a light brown colour. Pour out of pan. Set aside.
5. Place pumpkin in large bowl and mash with fork until a chunky consistency. Add browned butter, parmesan, oregano, sage and nutmeg. Stir to combine. Season to taste with salt and pepper.
6. Place 1 tablespoon of mixture over 2 sheets of pasta. Make sure to leave a 5cm gap between each tablespoon of filling. Brush around each filling with egg.
7. Gently place the two remaining pieces of pasta on top of the filling. Gently press around the filling, making sure to get rid of all the excess air. Using a 4cm cutter cut each piece of filling out of pasta sheets.
8. Fill a large saucepan with water, bring to the boil.
9. Place pasta in boiling water. Cook for 3-4 minutes or until just tender, drain.
10. Toss pasta through the oregano pesto. Season to taste with salt and pepper. Garnish with fresh sage, if desired. Serve.

Recipes continued

Triple Mushroom, Parmesan and Truffle Lasagne

Serves: 6-8

- 1 quantity traditional pasta
- 1 cup grated parmesan cheese
- 150g Portobello mushrooms, thickly sliced

Béchamel Sauce:

- 100g butter
- ½ cup plain flour
- 4 cups milk
- 1 cup grated parmesan cheese
- ½ cup ricotta cheese
- 1 tablespoon truffle oil

Mushroom Filling:

- 1 tablespoon olive oil
 - 2 cloves garlic, crushed
 - 2 onions, finely chopped
 - 500g Portobello mushrooms, chopped
 - 200g brown mushrooms, chopped
 - 200g shiitake mushrooms, chopped
 - 1 cup white wine
 - 4 sprigs fresh thyme
 - 1 cup thickened cream
 - 1 tablespoon lemon juice
- Salt and freshly ground black pepper, to taste

1. Béchamel Sauce: Melt butter in a medium saucepan over medium heat. Add flour and stir to form a paste. Slowly add milk, while stirring. Bring to a simmer. Stir constantly until thickened. Remove from heat. Stir through parmesan, ricotta and truffle oil. Season to taste with salt and pepper. Set aside.

2. Mushroom Filling: Heat oil in a large saucepan over medium heat. Add garlic, onion and mushrooms. Cook for 5-6 minutes or until mushrooms have softened. Add wine and allow to reduce by half. Add thyme, cream and lemon juice. Bring to a simmer and cook for a further 2 minutes. Season to taste with salt and pepper. Set aside.
3. Preheat oven to 180°C. Grease a large casserole dish, 20 x 30cm.
4. Place pasta sheets on the base of casserole dish. Layer with mushroom sauce and béchamel. Continue to layer in order and top with a final layer of pasta. Top pasta with parmesan cheese and thick slices of portobella mushrooms. Cover with tinfoil. Bake for 20 minutes. Remove foil and cook for a further 15 minutes or until parmesan is golden. Serve.

Recipes continued

Beef Lasagne with Pancetta and Thyme

Serves: 6-8

1 quantity of traditional pasta, rolled into lasagne sheets

Filling:

2 tablespoons olive oil

3 cloves garlic, crushed

2 onions, finely chopped

3 celery sticks, diced

200g pancetta, roughly chopped

1.2kg ground beef

½ cup tomato paste

2 cups red wine

3 x 400g cans cherry tomatoes

1 cup fresh basil

¼ cup balsamic vinegar

¼ cup roughly chopped fresh oregano

Salt and freshly ground black pepper, to taste

Béchamel Sauce:

100g butter

½ cup plain flour

4 cups milk

1 cup grated parmesan cheese

½ teaspoon ground nutmeg

Salt and freshly ground black pepper, to taste

Grated parmesan, to garnish

1. Heat oil in a large saucepan over medium heat. Add garlic, onion, celery and pancetta. Cook for 5-6 minutes or until onions are translucent.

2. Add beef to the saucepan. Cook for 4-5 minutes. Add tomato paste and cook for 2-3 minutes or until beginning to caramelise.

3. Pour in wine to release the pan sediments, add remaining filling ingredients. Reduce heat to medium-low and allow to cook for 1 hour or until thickened. Season to taste with salt and pepper.

4. **Béchamel:** Melt butter in a medium saucepan over medium heat. Add flour and stir to form a paste. Slowly add milk, while stirring, bring to a simmer stirring constantly until thickened. Remove from heat. Stir through parmesan and nutmeg. Season to taste with salt and pepper. Set aside.

5. Preheat oven to 180°C. Grease a large casserole dish, 20cm x 30cm.

6. Place pasta sheets on the base of casserole dish. Layer with beef and béchamel. Continue to layer in order and top with a final layer of pasta. Top pasta with one final layer of béchamel sauce and extra parmesan cheese, if desired. Cover with tinfoil. Bake for 20 minutes. Remove foil and cook for a further 15 minutes or until parmesan is golden. Serve.

Recipes continued

Pumpkin, Ricotta and Sage Cannelloni

Serves: 6-8

- 1 quantity of Pumpkin pasta, rolled into Lasagne sheets
- 700g butternut pumpkin, peeled, roughly chopped
- ¼ cup olive oil
- 2 leeks, finely sliced
- 3 fresh sage leaves, finely sliced
- 1 cup ricotta cheese
- ½ cup toasted walnuts, roughly chopped
- 1 tablespoon lemon juice
- 2 teaspoons lemon zest
- 1 teaspoon verjuice
- Salt and freshly ground black pepper, to taste

Béchamel Sauce:

- 80g butter
- ⅓ cup plain flour
- 4 cups milk
- ¼ cup white wine
- ½ cup ricotta cheese
- Salt and freshly ground black pepper, to taste

1. Preheat oven to 180°C. Line a baking tray with baking paper.
2. Scatter pumpkin across baking paper and drizzle with half of the oil. Bake for 25-30 minutes or until golden brown.
3. Meanwhile heat remaining oil in a small saucepan over medium heat. Add leeks and cook for 5 minutes or until softened. Add garlic and sage and continue to cook for 2-3 minutes. Remove from heat. Add remaining ingredients. Stir to combine. Season to taste with salt and pepper. Set aside.

4. Béchamel: Melt butter in a medium saucepan over medium heat. Add wine and flour, stir to form a paste. Slowly add milk, while stirring and bring to a simmer, stir constantly until thickened. Remove from heat. Stir through ricotta cheese. Season to taste with salt and pepper. Set aside.
5. Pour approximately 1 cup of béchamel sauce into the base of a 20cm x 30cm casserole dish.
6. Lay pasta sheets on a lightly floured surface. Cut into 6-8cm strips. Place 2 tablespoons of pumpkin mixture down the centre of each piece of pasta. Roll into a cylinder and place into the prepared baking dish. Repeat with remaining pasta until the dish is full. Cover with remaining béchamel sauce. Cover with tinfoil. Bake for 20 minutes. Remove foil and cook for a further 15 minutes or until béchamel is golden and bubbling. Serve.

Recipes continued

Traditional Cannelloni with Buffalo Mozzarella

Serves: 6-8

1 quantity of traditional pasta, rolled into lasange sheets

20g butter

2 cloves garlic, crushed

2 onions, chopped

½ cup chopped fresh oregano

1 teaspoon dried basil

1 teaspoon ground nutmeg

1 teaspoon dried oregano

1 kg ground beef

½ cup tomato paste

700ml jar tomato puree

220g jar chargrilled capsicums, drained, roughly chopped

1 cup chopped fresh basil

Salt and freshly ground black pepper, to taste

Cheese Sauce:

500g crème fraîche

1 ½ cups ricotta cheese

1 cup parmesan cheese

200g buffalo mozzarella cheese, roughly grated

Salt and freshly ground black pepper, to taste

1. Melt butter in a large saucepan over medium heat. Add garlic, onions, oregano and nutmeg. Cook for 4-5 minutes or until onions are translucent. Add beef and cook for 5-6 minutes.

2. Add tomato paste and cook, stirring, for 2-3 minutes or until caramelised. Add remaining ingredients. Bring to a simmer.

Reduce heat to medium-low. Cook for 20-25 minutes or until thickened. Season to taste with salt and pepper. Set aside.

3. White sauce: in a large bowl combine crème fraîche, ricotta, parmesan and mozzarella. Stir to combine. Season to taste with salt and pepper.
4. Lightly cover the base of a 30cm x 40cm baking dish with white sauce.
5. Lay pasta sheets on a lightly floured surface. Cut into 6-8cm strips. Place 2 tablespoons of beef mince mixture down the centre of each sheet of pasta. Roll into a cylinder and place into the prepared baking dish. Repeat with remaining pasta until the dish is full. Cover with remaining white sauce. Cover with tinfoil. Bake for 20 minutes. Remove foil and cook for a further 15 minutes or until cheese sauce is golden and bubbling. Serve.

Notes

Notes



COMMERCIAL DESIGN GUARANTEED PERFORMANCE



The Sunbeam 5 Year Motor Guarantee

Sunbeam has built its reputation on manufacturing quality electrical appliances. Our Cafe Series® Planetary Mixmaster® Power Drive Bench Mixer is constructed from the highest quality materials. So much so, we guarantee our Bench Mixer motor for five (5) years against faulty materials or manufacture. This guarantee is just another expression of our confidence in the way we make appliances at Sunbeam. In order to be eligible for this guarantee, you must retain your receipt as proof of purchase.

Your Cafe Series® Planetary Mixmaster® Power Drive Bench Mixer is covered for the first year against faulty material or manufacture by the Sunbeam 12 Month Replacement Guarantee. Should you experience any difficulties with your appliance within this 12 Month period, please phone our customer service line for advice on 1300 881 861 in Australia, or 0800 786 232 in New Zealand.

The Sunbeam five (5) year motor guarantee begins from date of purchase and extends for four years beyond the 12 Month Replacement Guarantee. It covers only the motor, guaranteeing it against faulty materials or manufacture. It does not cover damage caused by accident, misuse or being used in a manner not in accordance with the Instruction Book. Similarly, this motor guarantee does not cover freight or any other costs incurred in making a claim.

If a fault should develop with the motor after the period covered by the 12 Month Replacement Guarantee, please call

Sunbeam Customer Service on the number listed below or send a written claim to Sunbeam at the address listed below. On receipt of your claim, Sunbeam will advise you on how to obtain a replacement motor if your motor is defective.

Alternatively, you can return the Cafe Series® Planetary Mixmaster® Power Drive Bench Mixer to any of Sunbeam's authorised service centres, together with your receipt. The service centre will examine the motor and if it is faulty or defective, the motor will be replaced free of charge.

For a complete list of Sunbeam's authorised service centres visit our website or call:

Sunbeam Corporation Ltd. Australia

www.sunbeam.com.au

1300 881 861

Units 5 & 6, 13 Lord Street
Botany NSW 2019 Australia

Sunbeam Corporation Ltd. New Zealand

www.sunbeam.co.nz

0800 786 232

Level 6, Building 5, Central Park
660-670 Great South Road
Greenlane, Auckland

In Australia, the benefits given to you by this guarantee are in addition to your other rights and remedies under any laws which relate to the appliance.

Our goods come with guarantees that cannot be excluded under the Australian Consumer Law and under the New Zealand Consumer Guarantees Act. In Australia you are entitled to a replacement or refund for a major failure and for compensation for any other reasonably foreseeable loss or damage. You are also entitled to have the goods repaired or replaced if the goods fail to be of acceptable quality and the failure does not amount to a major failure.

In New Zealand, depending on the nature of the goods, you may have various rights under the Consumer Guarantees Act 1993 and this 12 Month Replacement Guarantee does not affect such rights. You agree that this Act will not apply where you acquire, or hold yourself out as acquiring, our goods for the purposes of a business.

IMPORTANT NOTE

Sunbeam agrees to replace the motor in the event of the motor developing a fault or defect, within the four years after the 12 Month Replacement Guarantee.

As your Cafe Series® Planetary Mixmaster® Power Drive Bench Mixer needs to be assessed at a Sunbeam authorised service centre, it will not be accepted through retail stores.

If using the Cafe Series® Planetary Mixmaster® Power Drive Bench Mixer for commercial use this motor guarantee is limited to 12 months from the date of purchase.



COMMERCIAL DESIGN GUARANTEED PERFORMANCE

12 Month Warranty

This Sunbeam product is covered by a 12 month replacement or repair warranty, which is in addition to your rights under the Australian Consumer Law (if your product was purchased in Australia) or New Zealand Consumer Guarantees Act (if your product was purchased in New Zealand).

Should you experience any difficulties with your product during the warranty period, please contact our customer service line for advice on 1300 881 861 in Australia, or 0800 786 232 in New Zealand.

Alternatively, you can send a written claim to Sunbeam to:

Australia

Units 5 & 6, 13 Lord Street
Botany NSW 2019 Australia

New Zealand

Level 6, Building 5, Central Park
660-670 Great South Road
Greenlane, Auckland

Upon receipt of your claim, Sunbeam will seek to resolve your difficulties or, if the product is defective, advise you on how to obtain a replacement or refund.

To assist us in managing warranty claims, we recommend you register your product as soon as practicable after purchase by creating a MySunbeam account on our website and send a copy of your original receipt to Sunbeam.

In order to make a claim under our warranty, you must have the original proof of purchase documentation for the product and present it when requested.

Should your product develop any defect within 12 months of purchase because of faulty materials or workmanship, we will replace or repair it, at our discretion, free of charge. A product presented for repair may be replaced by a refurbished product of the same type rather than being repaired. Refurbished parts may be used to repair the product.

Our replacement or repair warranty only applies where a defect arises as a result of faulty material or workmanship during the warranty period. Your warranty does not cover misuse or negligent handling (including damage caused by failing to use the product in accordance with this instruction booklet), accidental damage, or normal wear and tear.

Your warranty does not:

- cover freight or any other costs incurred in making a claim, consumable items, accessories that by their nature and limited lifespan require periodic renewal (such as filters and seals) or any consequential loss or damage; or
- cover damage caused by:
 - power surges, power dips, voltage supply problems, or use of the product on incorrect voltage;
 - servicing or modification of the product other than by Sunbeam or an authorised Sunbeam service centre;
 - use of the product with other accessories, attachments, product supplies, parts or devices that do not conform to Sunbeam specifications; or
 - exposure of the product to abnormally corrosive conditions; or
- extend beyond 3 months if the product is used in commercial, industrial, educational or rental applications.

The benefits given to you by our warranty are in addition to other rights and remedies under law in relation to the product.

In Australia our goods come with guarantees that cannot be excluded under the Australian Consumer Law. You are entitled to a replacement or refund for a major failure and for compensation for any other foreseeable loss or damage. You are also entitled to have the goods repaired or replaced if the goods fail to be of acceptable quality and the failure does not amount to a major failure.

Our goods also come with guarantees that cannot be excluded under the New Zealand Consumer Guarantees Act.

If your warranty claim is not accepted, we will inform you and if requested to do so by you, repair the product provided you pay the usual charges for such repair. You will also be responsible for all freight and other costs.

Should your product require repair or service after the warranty period, contact your nearest Sunbeam service centre. For a complete list of Sunbeam's service centres, visit our website or call our customer service line for advice on 1300 881 861 in Australia, or 0800 786 232 in New Zealand.



COMMERCIAL DESIGN GUARANTEED PERFORMANCE

Need help with your appliance?

Contact our customer service team or visit our website for information and tips on getting the most from your appliance.

In Australia

Visit www.sunbeam.com.au

Or call 1300 881 861

In New Zealand

Visit www.sunbeam.co.nz

Or call 0800 786 232

Sunbeam is a registered trademark.

'Cafe Series' logo and words are registered trademarks of Sunbeam Corporation.

'Mixmaster' is a registered trademark of Sunbeam Corporation.

'Scapemaster' is a trademark of Sunbeam Corporation.

Made in China. Designed and engineered in Australia.

Due to minor changes in design or otherwise, the product may differ from the one shown in this leaflet.

© Copyright. Sunbeam Corporation Limited 2006.

ABN 45 000 006 771

Units 5 & 6, 13 Lord Street

Botany NSW 2019 Australia

Level 6, Building 5, Central Park

660-670 Great South Road

Greenlane, Auckland

New Zealand

Sunbeam Corporation is a division of GUD Holdings Ltd.